

# 30C3 VOC

The 30C3 video operation center  
– a joint venture of CCC and FeM e.V.



# VOC

- new, distributed team
- around 20 people
- two months of weekly mumble meetings, ~3h each
- 40 pads
- one preparation weekend

# New Stuff

- four tracks - one more than last year
- one HD 1080p track
- decentralized setup
- subtitles
- workshops recordings – continued
- new releasing platform (media.ccc.de API)

Rooms: G,2,6

30C3 colo

RZ Berlin / ? / ?

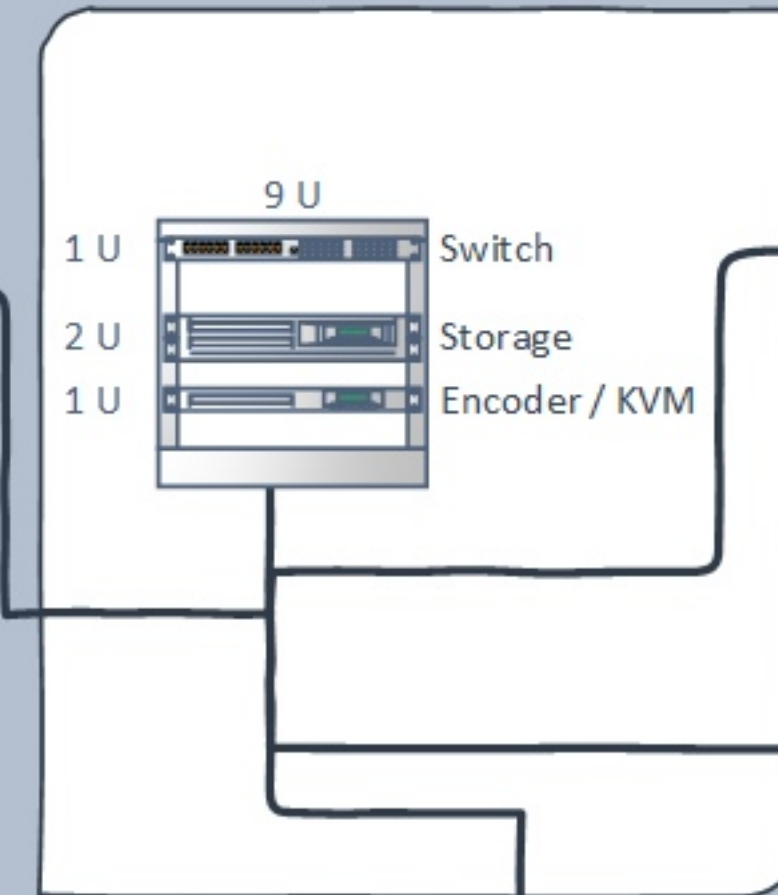
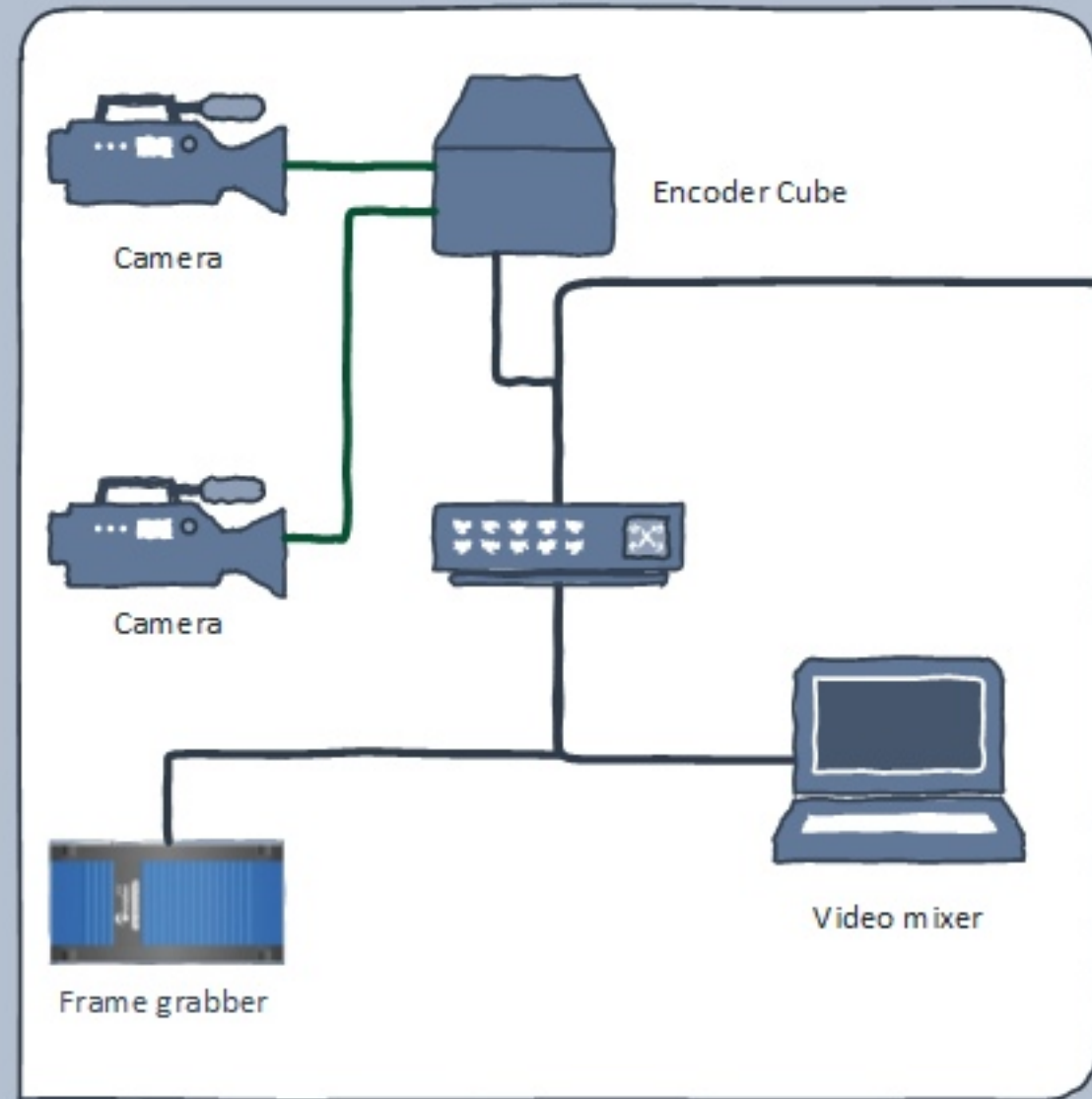

media.ccc.de

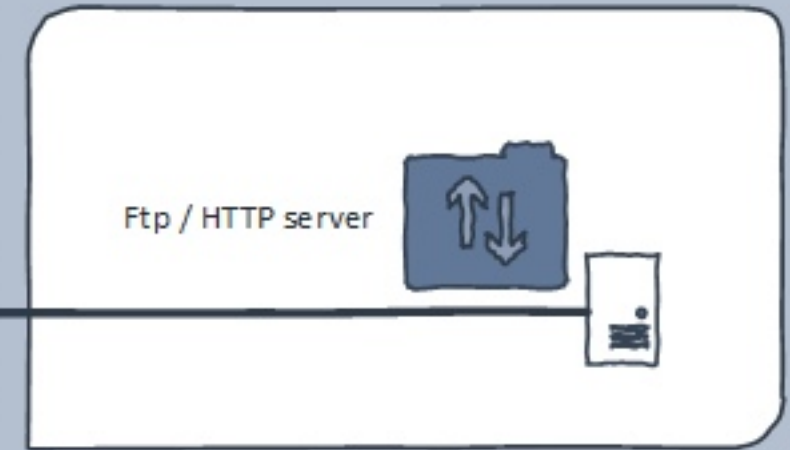

VOC:

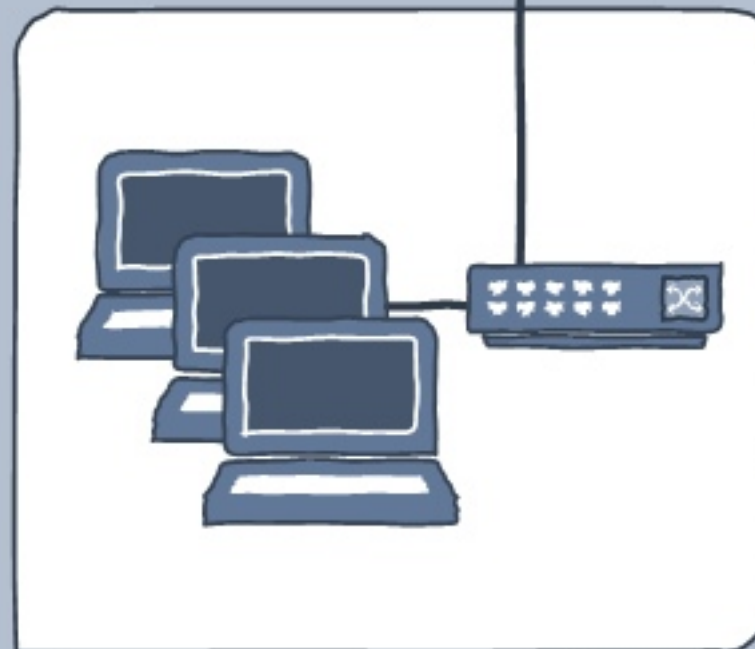

SDI  
IP

# Overview

# Saal AV

30C3

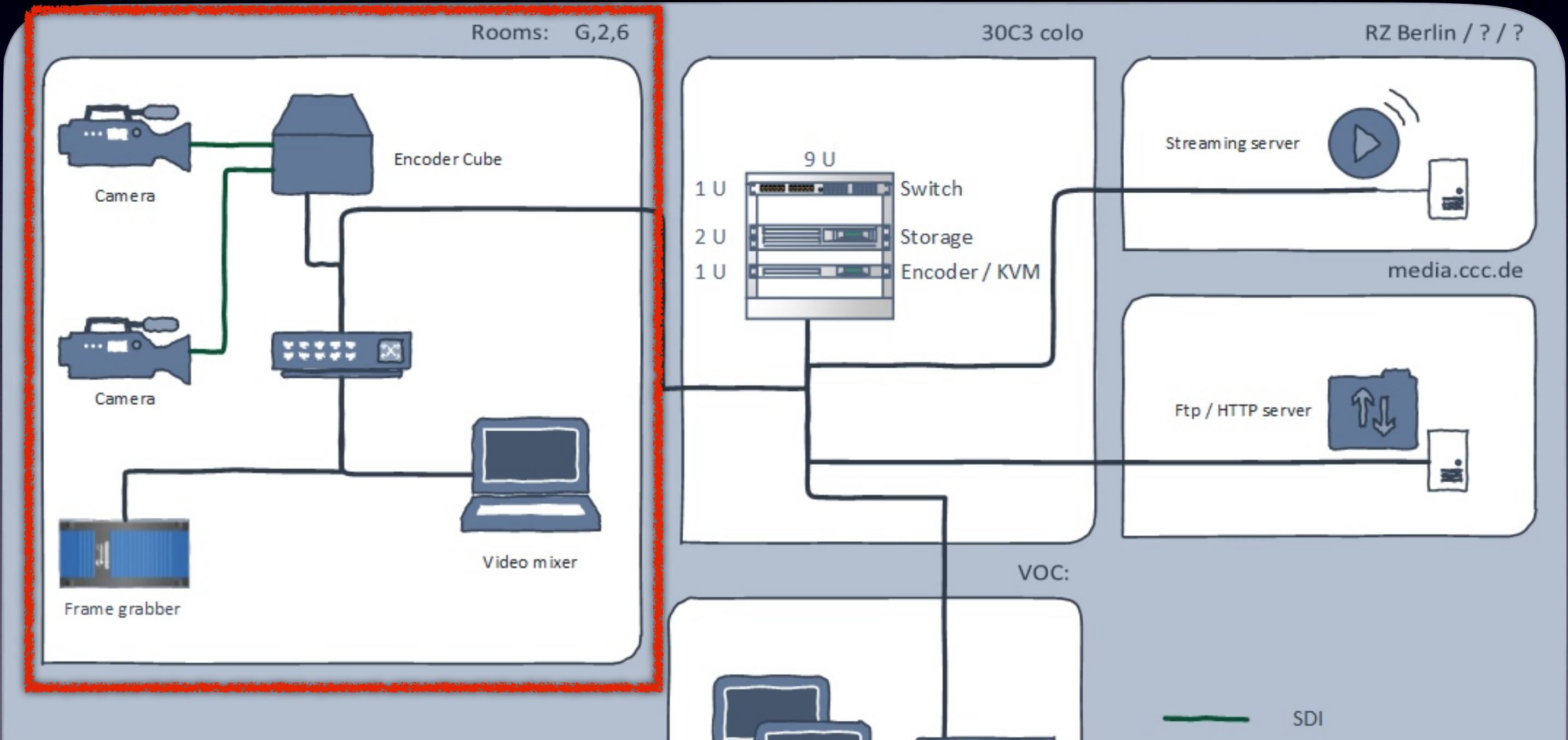

HD-SDI  
DVI

2x Audio von Audioanlage

Seite 1/1

Kamera  
1-3

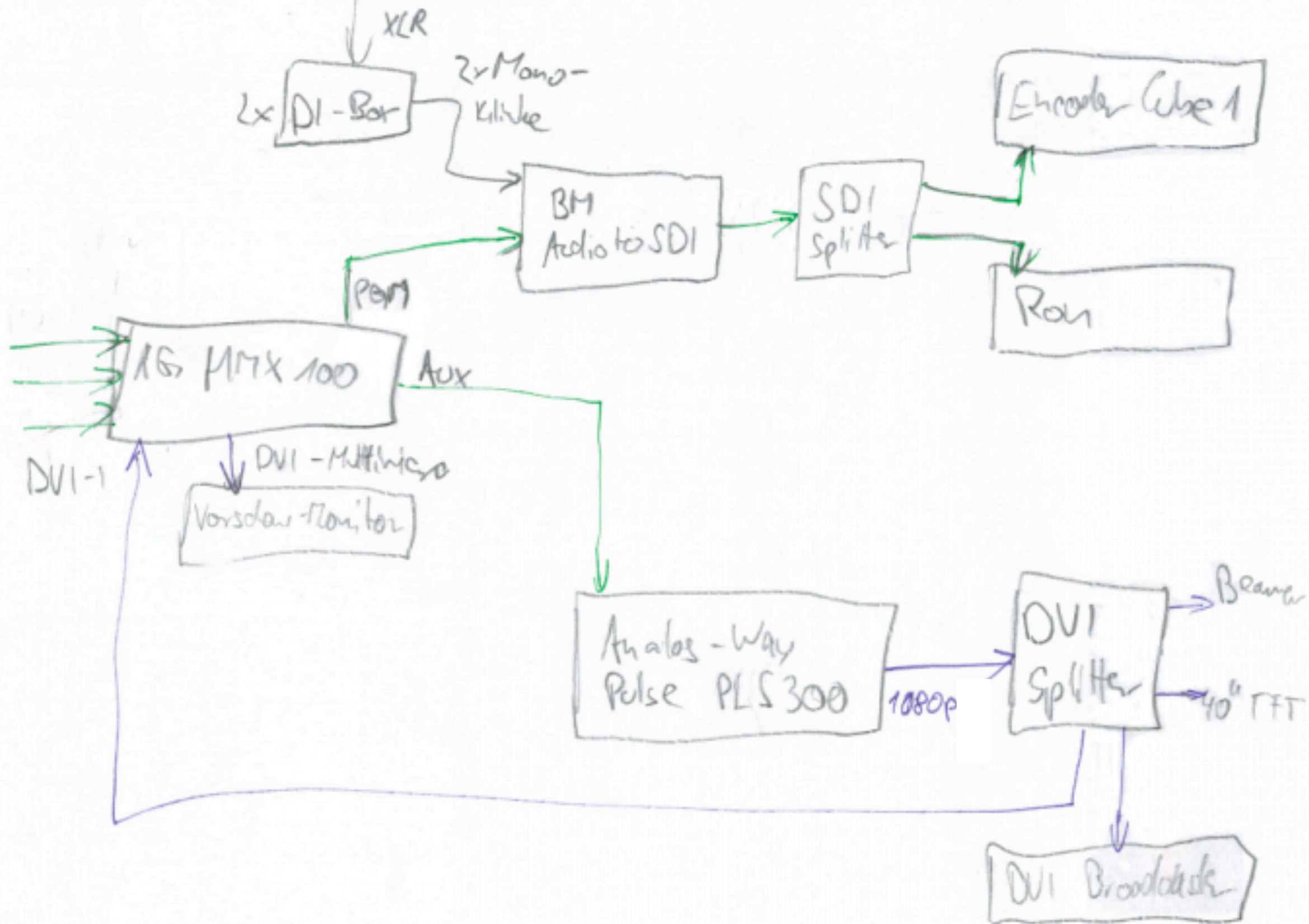

# CCC - Video Seal 1

Seitenrang rechts/vorne

(Vorschau-monitore für Switcher nicht eingezeichnet!)

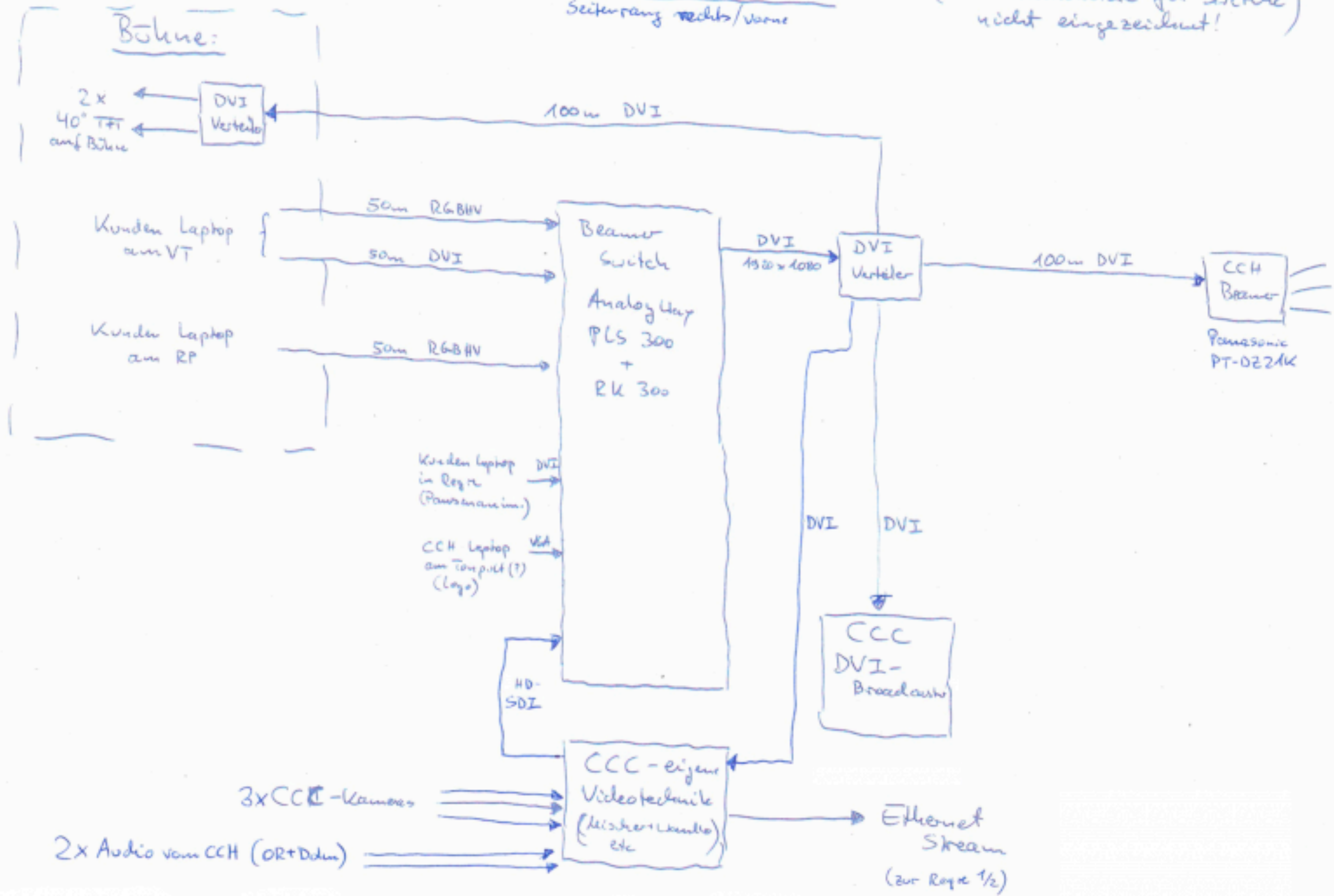

# EDID sim

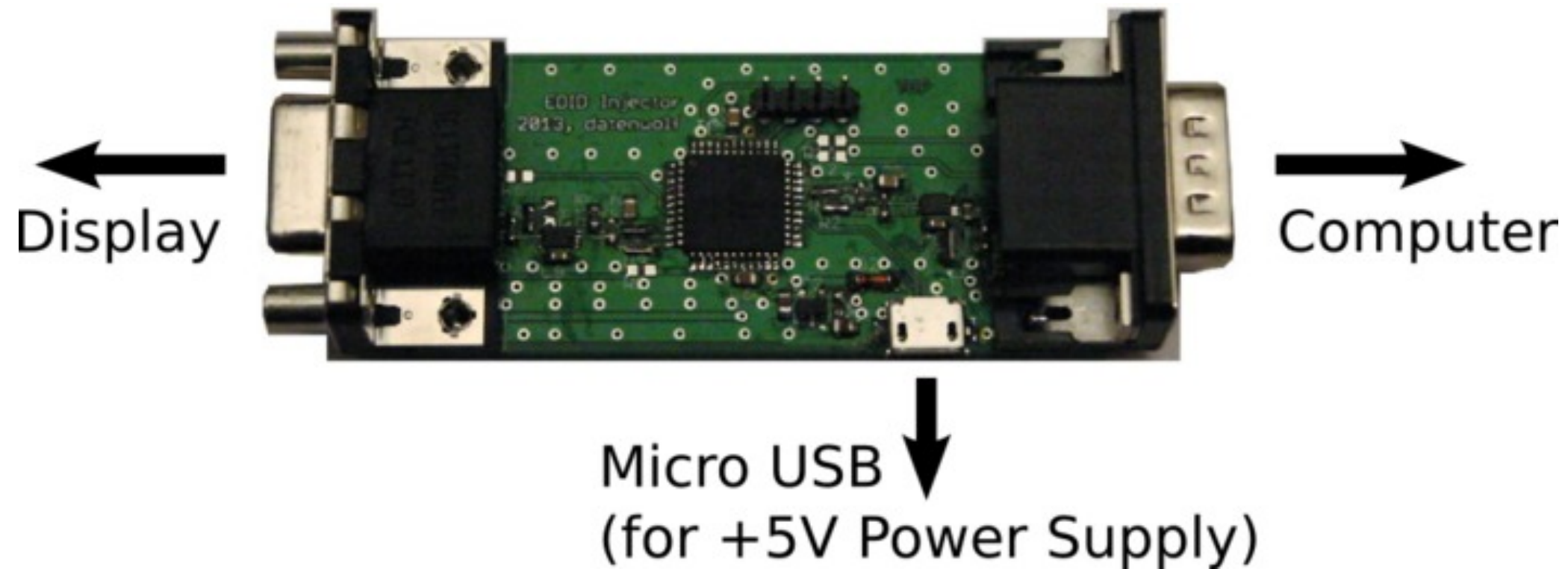

- <https://github.com/datenwolf/vgaedidinjector>
- [https://events.ccc.de/congress/2013/wiki/Projects:VGA\\_EDID\\_Injector](https://events.ccc.de/congress/2013/wiki/Projects:VGA_EDID_Injector)



# CCC - Video Seal 1

Seitenrang rechts/vorne

(Vorschau-Monitore für Sritche)  
nicht eingezeichnet!

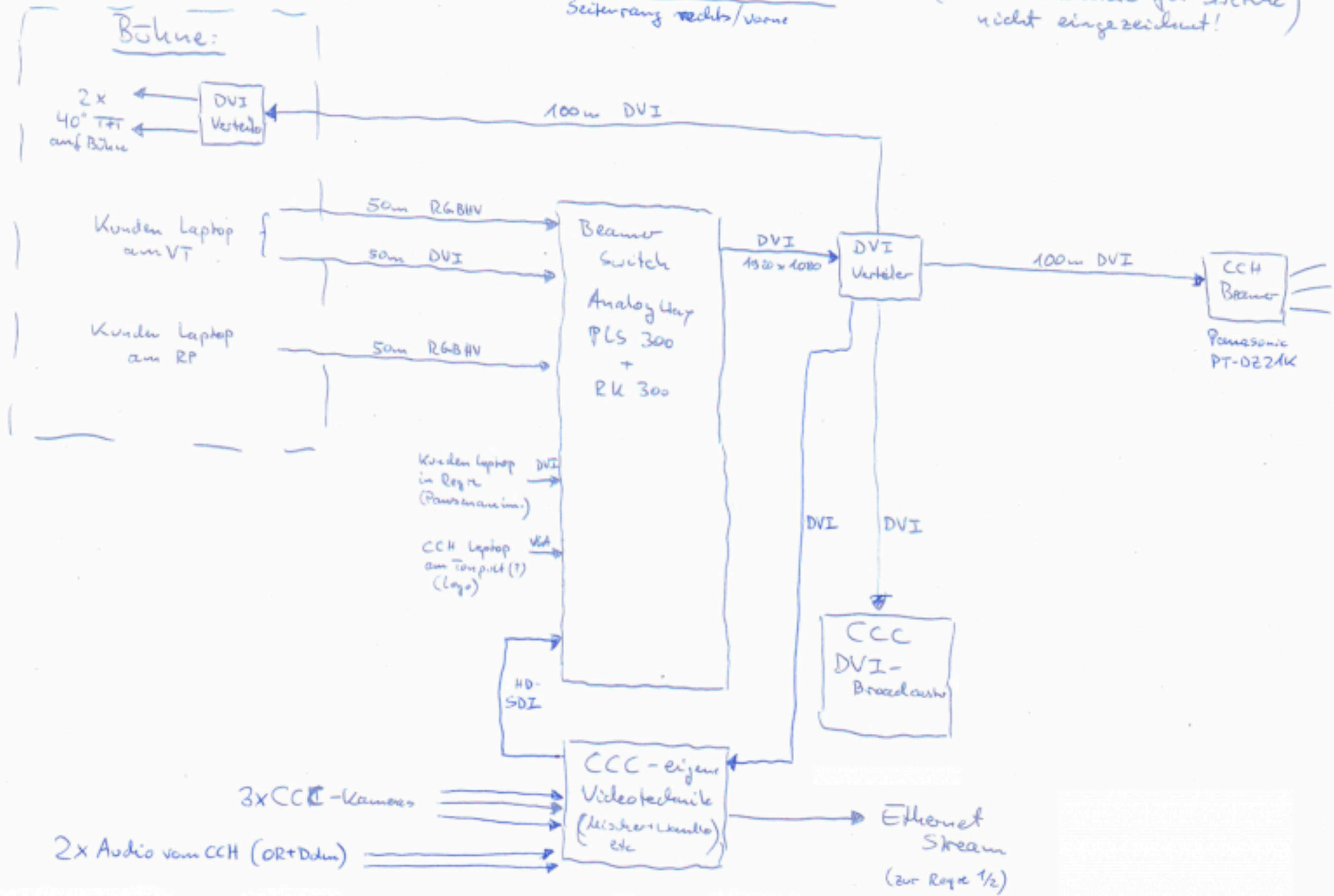

# VOC Colo

30C3

s: 1,G,2,6

30C3 colo

RZ Berlin / ? / ?

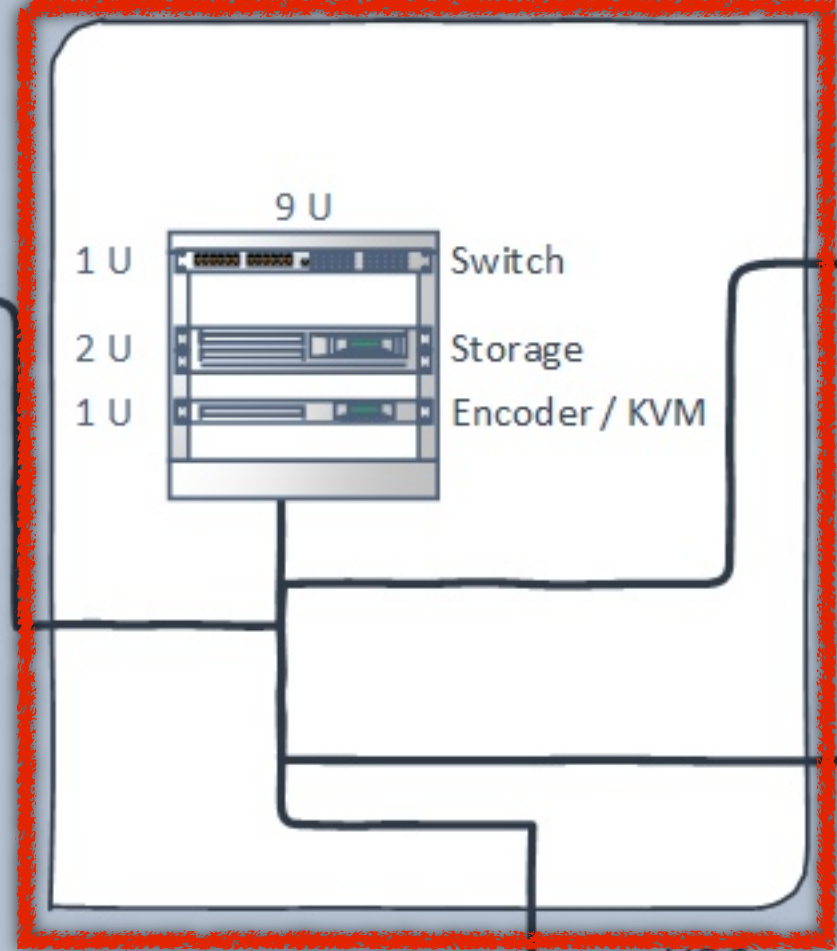

media.ccc.de

mixer

# Live streaming = CDN

30C3

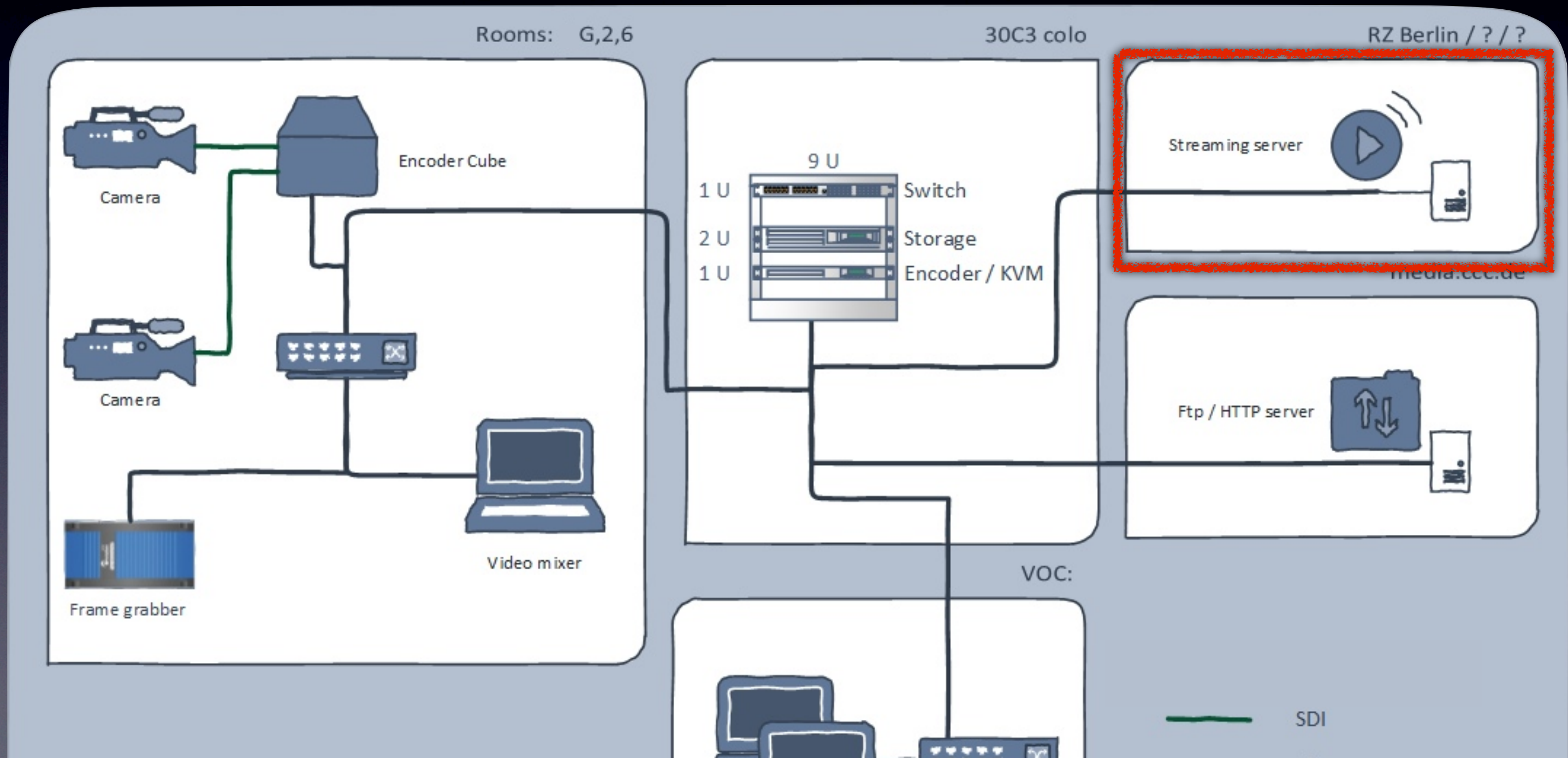

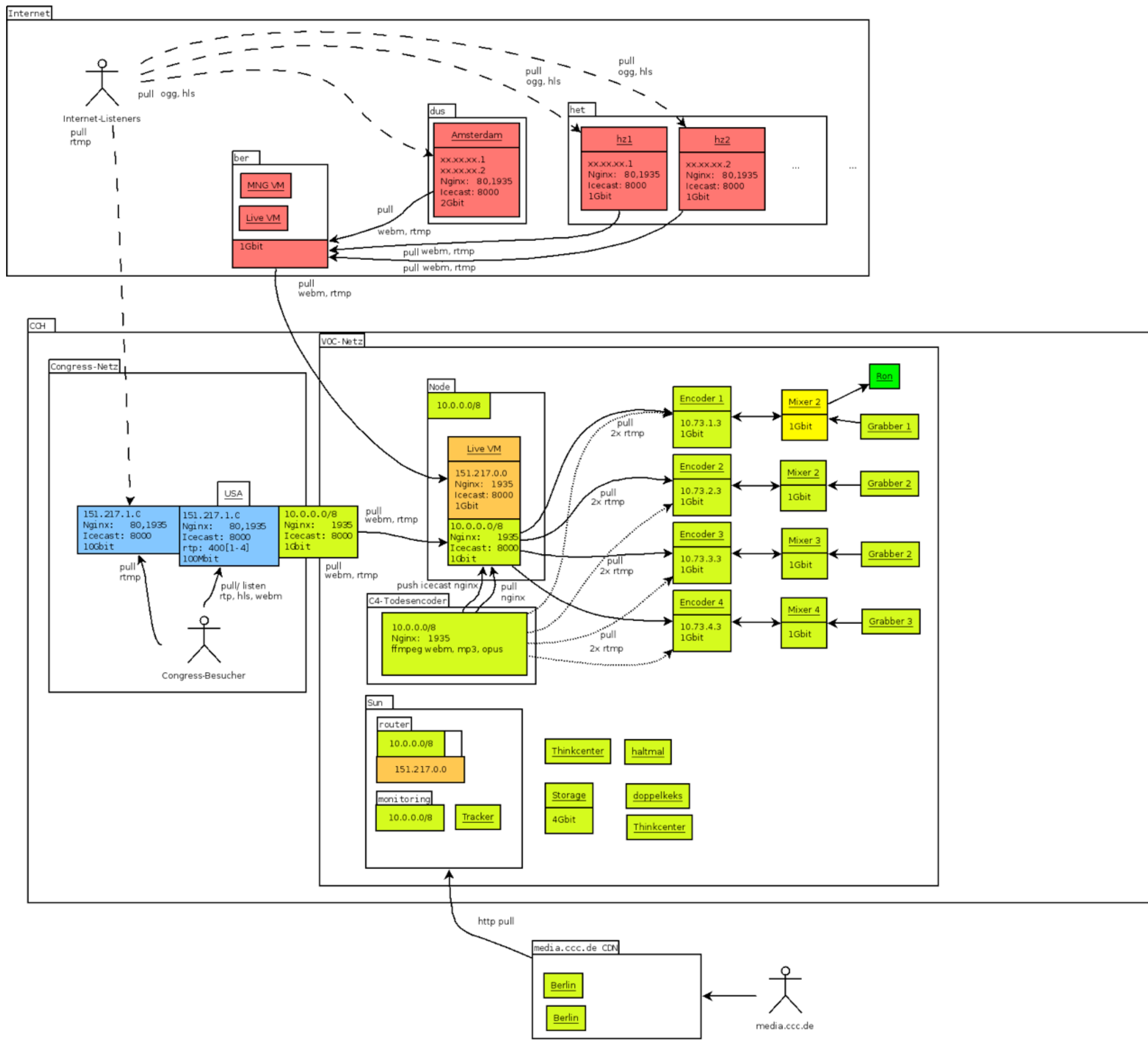

# CDN

- Icecast:  
WebM, Audio
- Nginx-RTMP:  
RTMP, HLS

# Live viewers statistics

- 34.89 TB of streams delivered to viewers
- 23.7 TB of that Saal I HD directly streamed from the CCH
- 24 Streaming relays
- Peak-Fefe: 10000+, avg 4500-6500

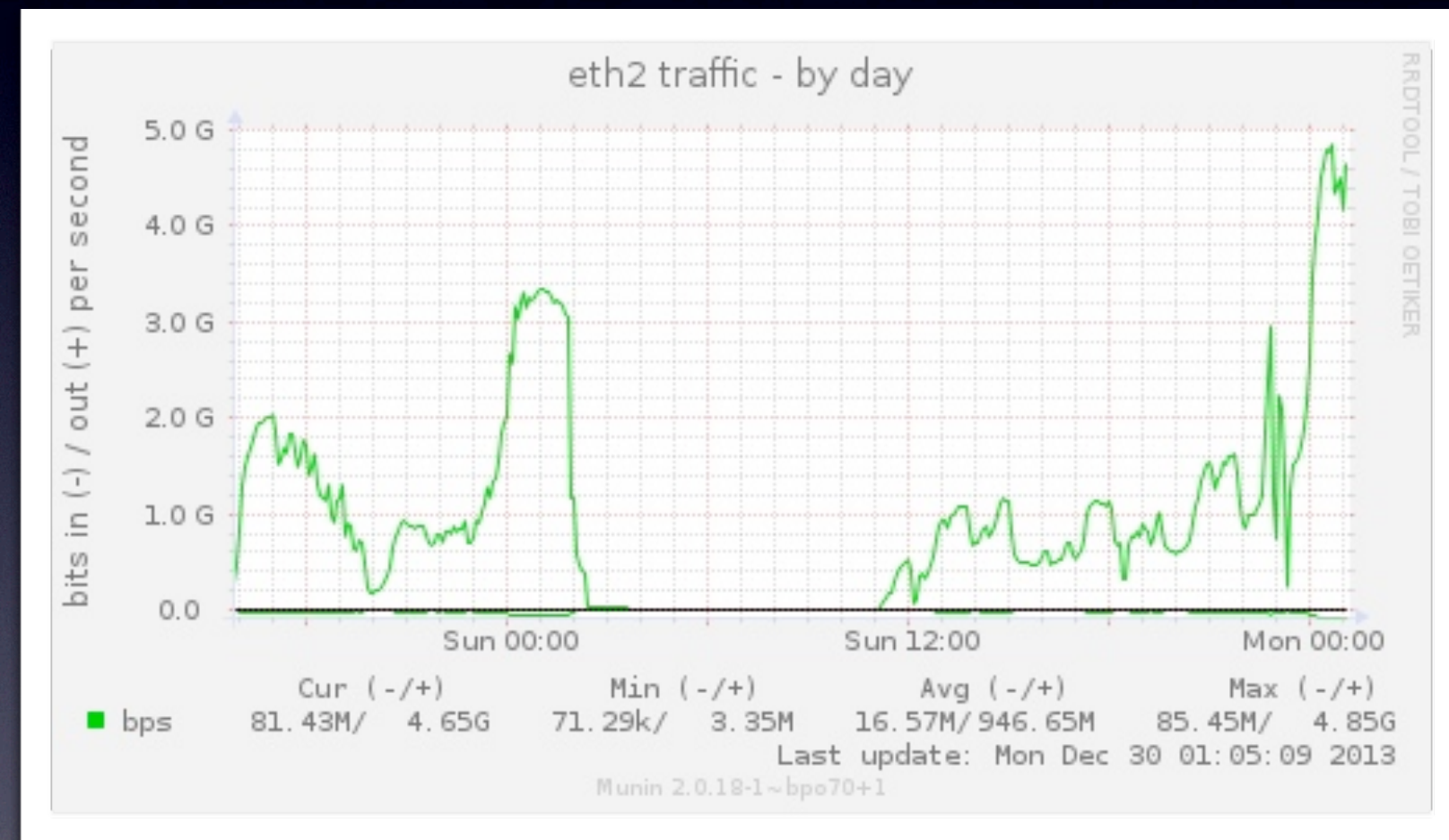

# Operations

- puppetize ALL THE THINGS!
- Nagios:  
69 Hosts – 2175 Checks

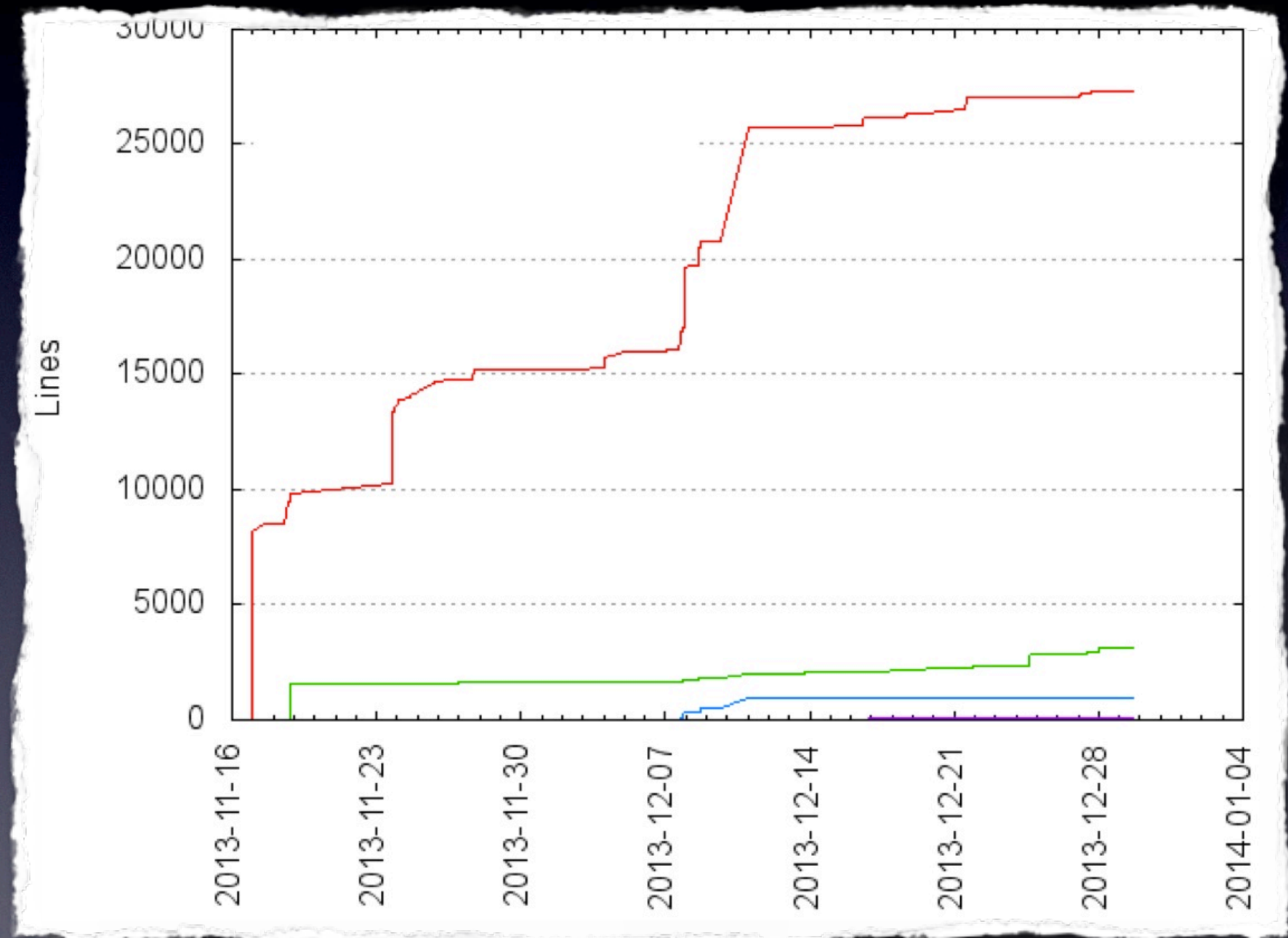

# Recordings – Releasing

- 62% talks released – as of Day3 11:50
- Rest hopefully coming today.
- Formats: MP4 AVC + iProd, WebM, Opus, MP3, SRT

5311	lasers in space	staged	Day 1	16:45	Saal 6	edit	>
	DV zu 2pass WebM	released				edit	>
	H.264 from DV HQ	released				edit	>
	H.264 from DV LQ	released				edit	>
	lasers in space (Recording)	finalized				edit	>
5337	Kryptographie nach Snowden	staged	Day 1	17:15	Saal 2	edit	>
	DV zu 2pass WebM	released				edit	>
	H.264 from DV HQ	released				edit	>
	H.264 from DV LQ	material needed				edit	>
	Kryptographie nach Snowden (Recording)	finalized				edit	>
5527	Basics of Digital Wireless Communication	staged	Day 1	17:15	Saal G	edit	>
	DV zu 2pass WebM	released				edit	>
	H.264 from DV HQ	released				edit	>
	H.264 from DV LQ	material needed				edit	>
	Basics of...Communication (Recording)	finalized				edit	>
5447	Policing the Romantic Crowd	staged	Day 1	17:30	Saal 6	edit	>
	DV zu 2pass WebM	postencoded				check	edit >
	H.264 from DV HQ	released				edit	>
	H.264 from DV LQ	material needed				edit	>
	Policing the Romantic Crowd (Recording)	finalized				edit	>
5529	Hardening hardware and...a #goodBIOS	staged	Day 1	18:30	Saal 2	edit	>
	DV zu 2pass WebM	postencoded				check	edit >
	H.264 from DV HQ	released				edit	>
	H.264 from DV LQ	material needed				edit	>
	Hardening...#goodBIOS (Recording)	finalized				edit	>

# Subtitles

- Pad texts needs to be synced
- Volunteers needed! (You!)
- <http://subtitles.media.ccc.de/>
- <https://events.ccc.de/congress/2013/wiki/Projects:Subtitles>

## 30C3: Subtitles

VID	Title	
5610	Seidenstraße	Pad Video on amara.org
5377	Überwachen und Sprache	Pad Video on amara.org
5415	Der tiefe Staat	Pad Video on amara.org
5307	Reverse engineering of CHIASMUS from GSTOOL	Pad Video on amara.org
5224	Triggering Deep Vulnerabilities Using Symbolic Execution	Pad Video on amara.org
5497	10 Years of Fun with Embedded Devices	Pad Video on amara.org
5476	Electronic Bank Robberies	Pad Video on amara.org
5509	IFGINT	Pad Video on amara.org
5298	Rock' em Graphic Cards	Pad -
5311	lasers in space	Pad Video on amara.org
5337	Kryptographie nach Snowden	Pad -
5527	Basics of Digital Wireless Communication	Pad -
5447	Policing the Romantic Crowd	Pad -
5529	Hardening hardware and choosing a #goodBIOS	Pad -
5526	Let's Distrust Quantum Communication	Pad -



# Angels are awesome!

- 118 audio/video angels
- ~9 VOC hall coordinators
- 50 - 60 heralds
- 12 - 15 translation angels
  - all german talks where translated into english again
- unknown number of subtitlers

# Fuckups

- Memleaks during recording of the opening event
- Stream #0:1[0x101]:Audio: aac ([15][0][0][0] / 0x000F), 0 channels, fltp
- Various network outages
- media.ccc.de API:

```
dir = get_recording_dir;  
FileUtils.remove_dir dir if File.directory? dir
```

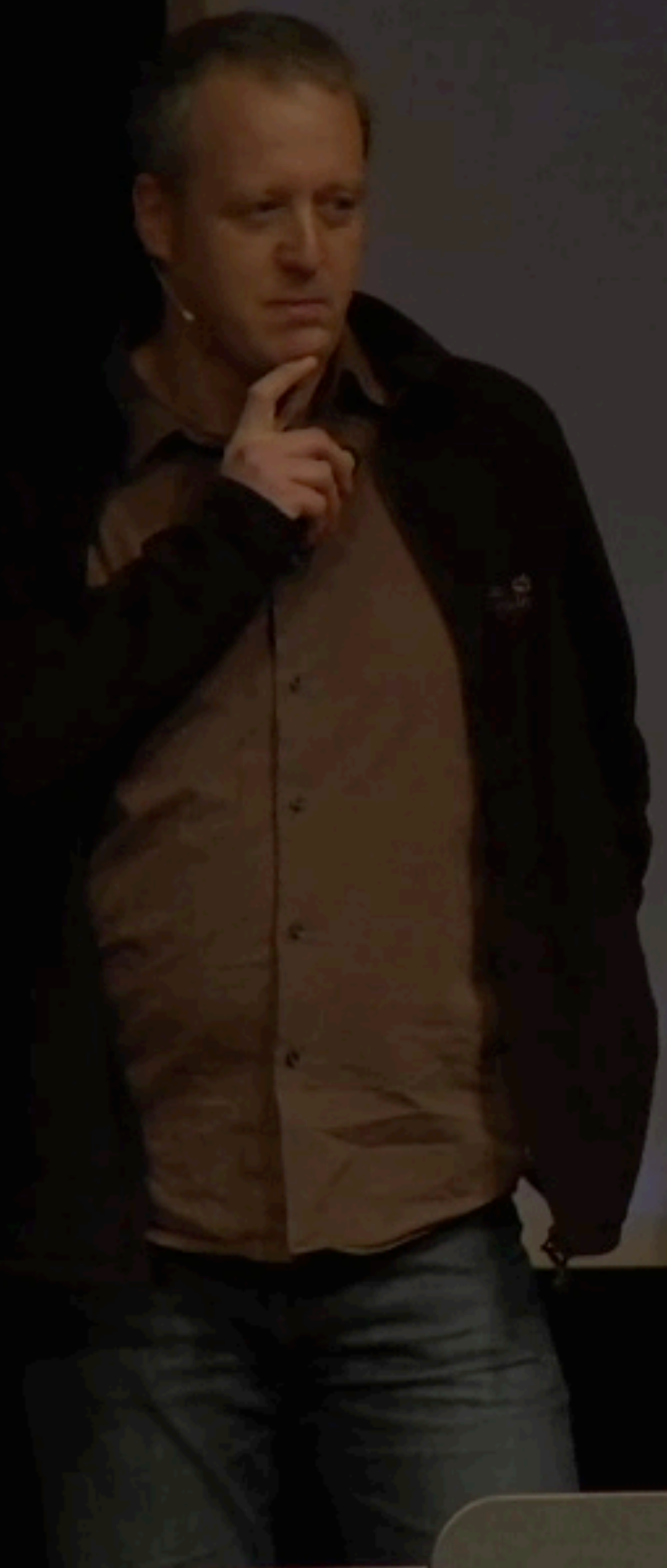

Chaos Communication Congress